



The joy of washing bottles

erich **baumgartner** **tec**hnik - industrial rinsing

General importer for



Industrial washing machines

## Product information bottle washing machines



**suitable for all bottles from 0.1 l to 2.0 l (or bottle height of 400 mm), beer barrels of up to 30 litres in EURO or DIN standard as well as beverage crates.**



Equipped with a bottle basket as well as a crate carrier insert as standard.



The washing and rinsing system which was specially developed for the cleaning of bottles, guarantees that all kinds of bottles (beer bottles, milk bottles, juice bottles, water bottles, yoghurt jars and much more) are washed germ-free inside and outside.

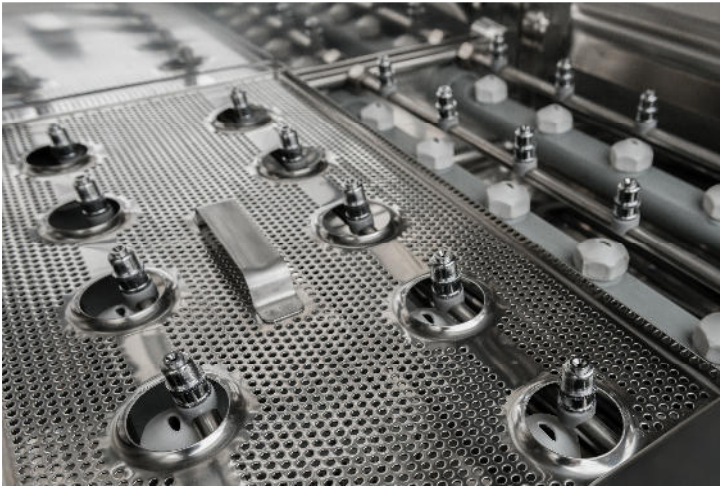

2 separate rinsing processes (washing and rinsing) guarantee hygiene at highest level also for small quantities of wash items.

Efficient and cost efficient.

The strainer makes sure that detached labels from the bottles do not enter into the detergent solution.

The washing program takes 6 minutes and 30 seconds. In a washing cycle of 6 minutes barely 2000 litres of detergent solution are circulated in the system. Depending on the type of bottle up to 54% of the circulation rate are flushed in the bottle and the remainder is flushed outside around the bottle. During the rinsing cycle about 8.7 l of fresh water are flushed in and around the bottles.

Functional principle:

The fresh water is controlled with a magnetic valve and conveyed into the washing chamber. Supported by a built-in booster pump the fresh water is sprayed into the washing chamber with the bottom rinsing nozzles.

At the same time chemicals for the detergent solution are conveyed into the washing chamber.

There are 2 heaters with a power of 4.5 kW each in the washing chamber. As soon as a filling level in the tank has been attained, the magnetic valve will switch on and the heater will start heating the water to about 57°C. If there is too little current available to the customer it would be possible to disconnect the heater. This would ensure that there will be waiting times between the individual washing cycles. A control lamp shows that the desired temperature has been attained.

By pressing the start button the detergent solution (29 l) in the tank will be circulated in the washing chamber. The washing pump conveys 330 l/min. of detergent solution in the washing chamber and cleans the bottles inside and outside.

In each washing cycle a quantity of fresh water of about 8.7 l is rinsed in and around the bottles by means of special nozzles. This way, the detergent solution is rinsed from the inside of the bottles and also required chemicals are conveyed into the tank in order to guarantee another hygienic cleaning.

After the washing cycle the machine will automatically heat the detergent solution to the preset washing temperature. A control lamp shows that the machine is ready-for-operation and another washing cycle can be performed.

The chemicals which are specially produced for our bottle washing machine can be used as liquid detergent to clean beer bottles or as enzyme powder to clean milk bottles and yoghurt jars.

The customer is free to use any other chemicals besides the one recommended by us. However, in this case we cannot be held liable for the sterility of the bottles or for the complete rinsing out of the detergent solution.

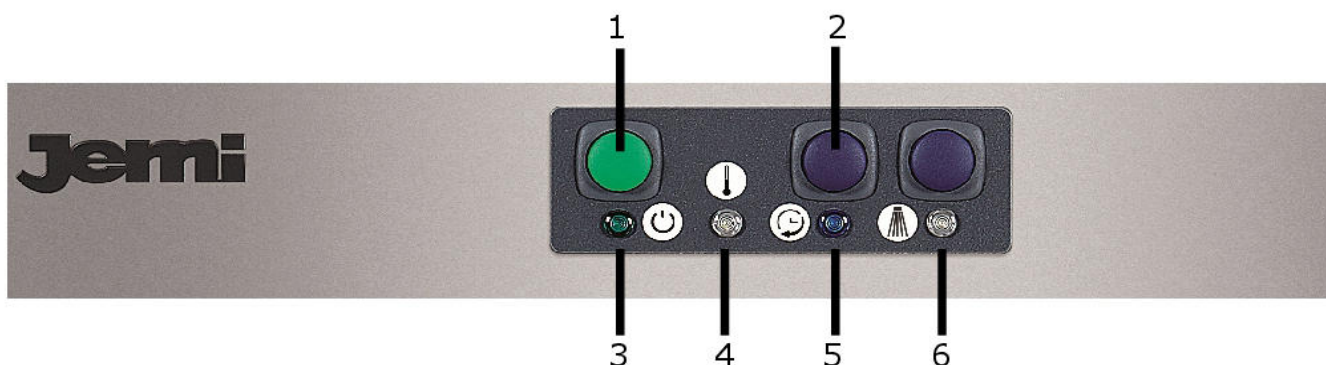
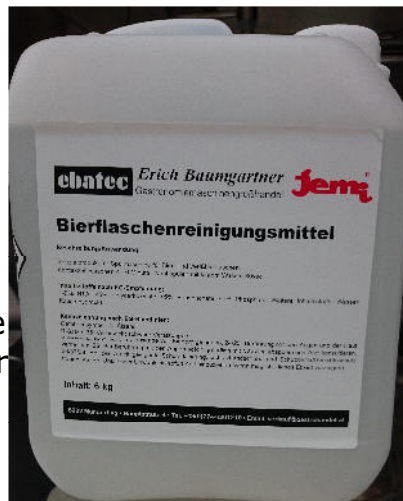

The new operating panel allows an easy and safe operation of the machine.

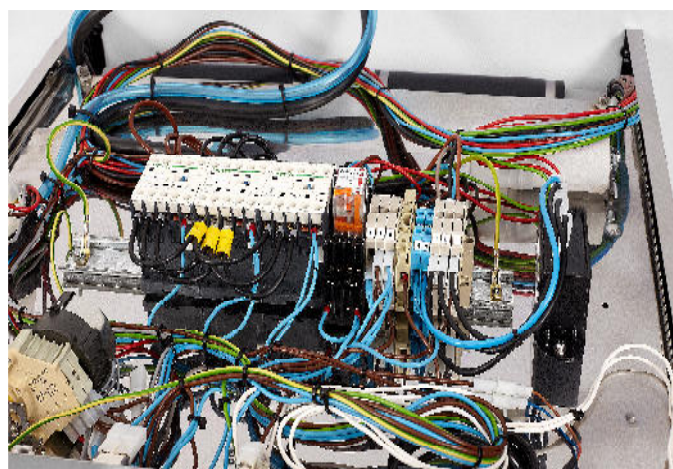
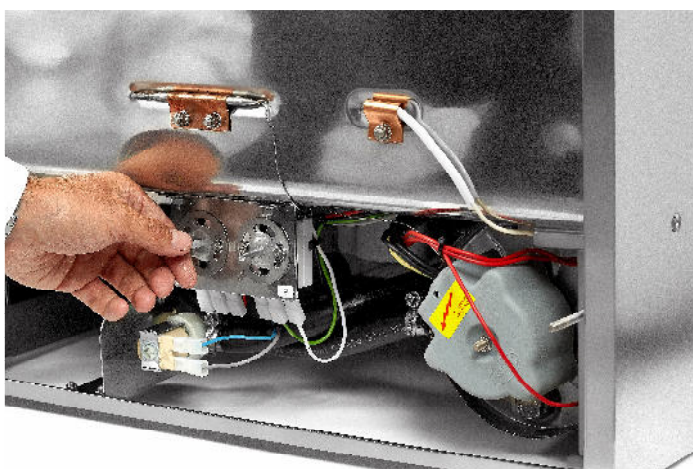

The whole technology of the bottle washing machine is electromechanical. No electronics or boards included. Therefore, the machine is easy to operate and a rapid troubleshooting is guaranteed.

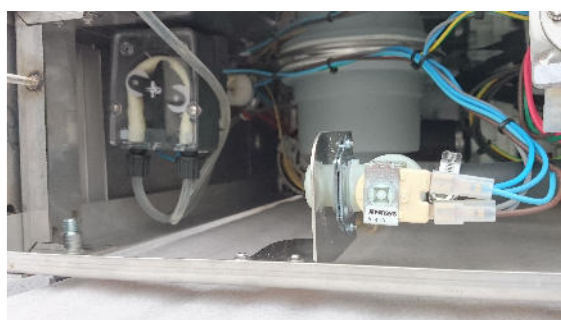

An automatic dosing for the liquid detergent is installed as standard.



The new booster pump guarantees washing cycle.

The recirculating pump for the detergent solution has a circulation rate of 330 l

By using the conversion KIT for barrel cleaning it is possible to convert the bottle washing machine to a barrel cleaning machine within a few minutes.

Rapidly and cost-efficient just as the whole bottle washing machine.

Customer responses:



Dear Mr. Baumgartner,

I am completely satisfied with the bottle washing machine made by the company Ebatec. The machine is perfect for the quantity of bottles used by us. The result of the cleaning is convincing and the installation as well as the operation are really easy to handle. The contact with the company Ebatec and the service were and are very good.

With best regards from the airport Munich

René Jacobsen  
Graduated master brewer

**René Jacobsen**  
Divisions restaurants - Municon - Catering  
Head of department brewery

**Allresto Flughafen München  
Hotel und Gaststätten GmbH**  
Terminalstraße Mitte 18  
D-85356 München-Flughafen

Phone +49 89 975 931 15  
Fax +49 89 975 931 18  
Mobile +49 174 909 51 13  
[rene.jacobsen@munich-airport.de](mailto:rene.jacobsen@munich-airport.de)  
[www.munich-airport.de](http://www.munich-airport.de)

The new brand positioning of the airport Munich. Experience more under <http://www.verbindung-leben.de>



Sehr geehrter Herr Baumgartner,

ich wollte Ihrem Team mal sagen das Ihrer Bierflaschenwaschmaschine viel Arbeit erspart und ein voller Erfolg bei uns ist.

Mit bierigen Grüßen

Daniel Bleicher  
**Cast-Brauerei**

Schlosserstr. 20/1

70180 Stuttgart

Tel.: 071112152694

Email: [castbrauerei@yahoo.com](mailto:castbrauerei@yahoo.com)

Webseite: [www.Cast-Brauerei.com](http://www.Cast-Brauerei.com)

Am 05.07.2016 um 10:18 schrieb Fa. ebatec-Baumgartner:

Seit einem halben Jahr ist die Bierflaschenwaschmaschine der Firma ebatec in meinem Besitz. Mit der Reinigung und der Handhabung der Maschine sind wir sehr zufrieden. Auch der Reinigungsmittel Verbrauch geht in Ordnung. Rüdiger Fröhle (Braumeister)

--

Hopfenschlingen GmbH

Militär Str. 2

76437 Rastatt

Telefon 07222 - 300 99

Fax: 07222 - 938165

Hallo Herr Baumgartner,  
Wie versprochen hier mein O-Ton:

"Für uns als Startup Craft-Brauerei eignet sich die Bierflaschenwaschmaschine von Firma ebatec optimal. Sie ist einfach zu bedienen, sicher und funktional."

Christoph Digwa, Gründer und Leiter der Gutshofbrauerei **Das Freie**

Beste Grüße und weiterhin viel Erfolg,

Christoph Digwa



Christoph Digwa

Gutshofbrauerei "Das Freie"

Gutshof Rethmar Betriebsgesellschaft mbH

Projektleiter Brauerei

M.Sc. Wirtschaftsingenieur

Gutsstr. 16

31319 Sehnde-Rethmar, Germany

Phone: +49 (0) 170 30 95 440

Fax: +49 (0) 5138 70 89 64 2

[christoph@digwa.de](mailto:christoph@digwa.de)

[www.gutshof-rethmar.de](http://www.gutshof-rethmar.de)

[www.facebook.com/dasfreie](https://www.facebook.com/dasfreie)

Hallo

Ich habe seit einem halben Jahr die Bierflaschenwaschmaschine von **ebatec** in Betrieb und bin sehr zufrieden.

Das sehr gute Preis – Leistungsverhältnis und ist ideal für meine Kleinbrauerei.

Freundliche Grüße

WENZL PRIVATBRÄU

Johann Kieslinger-Furtner

Wimberg 1, 4783 Wernstein am Inn

Hallo Erich,

hier mein Kommentar:

Die neue Flaschenwaschmaschine ist eine enorme Erleichterung. Sie arbeitet zuverlässig und sauber. Ich könnte mir ein Leben ohne sie nicht mehr vorstellen.

Liebe Grüße

Rudi



Privatbrauerei Rudolf Malle | Hochpirkachweg 3 | 9500 Villach | Telefon +43 660 7624040  
[braumeister@mallebier.at](mailto:braumeister@mallebier.at) | [www.mallebier.at](http://www.mallebier.at) | UID-Nummer: ATU56061807

Sehr geehrter Herr Baumgartner, lieber Erich!

unsere Flaschenwaschanlage ist jetzt doch schon eine geraume Zeit in Betrieb und funktioniert einwandfrei.

Die Flaschen sind sauber und somit hab ich keine Bedenken sie wieder mit Milch zu füllen und auszuliefern.

Danke für die gute Zusammenarbeit

Mit freundlichen Grüßen

Buachberger`s Mili

Fam. Aigner

Buchberg 1

5163 Mattsee

0664 53 06 641

mail: [info@buchbergmilch.at](mailto:info@buchbergmilch.at)

web: [www.buchbergmilch.at](http://www.buchbergmilch.at)

A-5222 Munderfing Hauptstraße 4 Phone: 0043 / 7744 / 20 12 10 Fax: 0043 / 7744 / 20 12 12 e-mail:

verkauf@gastrohandel.at **www.jemi.at**

Lieber Erich ,  
Lieber Martin,

Ich möchte mich hiermit noch für Eure geniale Flaschenwaschmaschine bedanken.  
Nach langer Suche, eine einfache aber Bestmögliche Art und Weise zu finden, Flaschen in  
unserer Gasthausbrauerei zu reinigen bin ich auf Euch gestoßen.

Im Februar 2016 habe ich schließlich nach nicht einmal 2 Wochen nach Bestellung die  
GS21 bei euch abgeholt. Seit dem bin ich absolut begeistert von Eurer Arbeit.

Die Installation am Standort Kaltental war sehr einfach und schon nach 20 Minuten ist die  
Maschine betriebsbereit. Der Reinigungsmittelverbrauch ist sehr sparsam und das bei  
bestem Waschergebniss. Auch die Endreinigung nach getaner Arbeit könnte nicht einfacher  
sein.

Im Großen und Ganzen ein sehr gut durchdachtes Projekt. – Kompliment

Mit Viel Freude beim Flaschenwaschen



Dominik Schempp  
Braumeister

Important installation instructions: The water outlet should not be higher than 60  
mm from the machine bottom.

Water supply: 2.5 bar permanent flow pressure,  
connection 3/4" (no Gardena hose)

Power requirement: 10 kW 400 volts

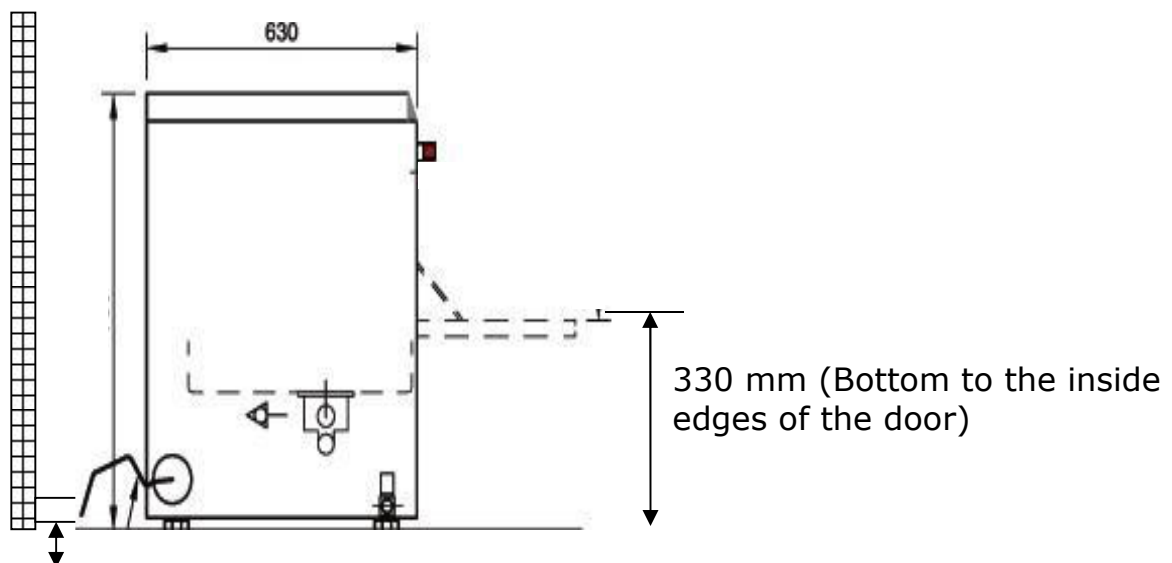

Bottom edge water outlet 50 – 60 mm  
Machine height 820 mm

Technical data:

WEEE-Reg.No.:	DE 51131709
Hourly output	about 190 bottles/h
Rinsing time:	6 min. 30 sec.
Pump capacity:	736 W
Circulation rate:	330 l. / min.
Tank heater:	2 x 4500 W
Overall connected load:	9736 W
Voltage:	400 volts
Tank contents:	29 l.
Water consumption/rinsing cycle:	about 8.7 l
Required permanent flow pressure:	2.5 bars
Connection/Supply and drain	$\frac{3}{4}$ " 50 mm Ø
Rack height:	Bottles of up to 400 mm
Basket dimensions:	500 x 500 mm
Equipment of baskets:	1 bottle basket
	1 crate carrier for beer crates
Dimensions:	
Width:	580 mm
Depth:	650 mm
Height incl. feet:	820 mm

Example of cost calculation for 10 washing cycles = 200 bottles:

Water consumption:		
Filling of 29 l + 10 washing cycles of 8.7 l = 116 l	= €	0,428
Power consumption:		
At a supply temperature of +6°C about 7 kWh current	= €	1,750
Consumption of chemicals:		
Factory setting 2.2g/l Fresh water = 255 g	= €	1,445

Thus the cleaning of 200 bottles will cost about € 0,0181 per bottle.

Net prices plus VAT:

Beer bottle washing machine GS 21 incl.: 1 bottle basket, 1 crate carrier, dosing pump, strainer, booster pump and connection material installed.

Complete price €	2.980,--
Bottle basket extra €	320,--
Conversion kit for barrel cleaning €	480,--
Beer bottle cleaning chemicals 6 kg package €	34,--
Transportation costs within Austria €	100,--
Transportation costs to Germany €	130,--

[www.facebook.com/flaschenwaschen](http://www.facebook.com/flaschenwaschen)  
[www.flaschenwaschen.com](http://www.flaschenwaschen.com)

I would like to say to your team that your beer bottle washing machine saves a lot of work and is a great success.

With beery regards

Daniel Bleicher

CAST-Brauerei

Schlosserstr. 20/1

D-70180 Stuttgart

Phone: 071112152694

E-Mail: [castbrauerei@yahoo.com](mailto:castbrauerei@yahoo.com)

Website: [www.Cast-Brauerei.com](http://www.Cast-Brauerei.com)

I have had the beer bottle washing machine made by the company ebatec for the past 6 months. We are very satisfied with the cleaning and operation of the machine. Also the consumption of detergent is OK. Rüdiger Fröhle

Hopenschlingen GmbH

Militär Str. 2

D-76437 Rastatt

Phone 07222 – 300 99

Fax. 07222 938165

Hallo Mr. Baumgartner,

as promised please find following my opinion.

For us as a start-up craft brewery the beer bottle washing machine made by the company ebatec is perfectly suitable. It is easy to operate, safe and functional.

Christoph Digwa, the founder and head of the farm brewery **Das Freie**

Best regards and lots of success further on

Christoph Digwa

Hallo,

I have had the beer bottle washing machine made by the company ebatec for the past 6 months and I am very satisfied.

The good price performance ratio is perfect for my small brewery.

Kinds regards

WENZL PRIVATBRÄU

Johann Kieslinger-Furtner

Wimberg 1, 4783 Wernstein am Inn

Hallo Erich,

Please find my comment as follows:

the new bottle washing machine is an enormous relief. It works reliably and clean. I could no longer imagine a life without it.

Warm greetings

Rudi

Malle biermanufaktur

Dear Mr. Baumgartner, Dear Erich!

Our bottle washing machine has been operated for sometime now and is working perfectly. The bottles are clean and this way I have no doubts to refill them with milk and deliver the milk to our customers.

Thank you very much for the good cooperation

Kind regards

Buachberger's Mill

Fam. Aigner

Buchberg 1

5163 Mattsee

06645306641

Mail: [info@buchbergmilch.at](mailto:info@buchbergmilch.at)

Web: [www.buchbergmilch.at](http://www.buchbergmilch.at)

Dear Erich,

Dear Martin,

I would herewith like to thank you for your brilliant bottle washing machine.

After having search for a long time for an easy but best possible way to clean the bottles in our tavern brewery I found you.

In February 2016 I picked up the GS21 at your premises only two weeks after having placed my order. Since that day I am absolutely enthused by our work.

The installation at the site in Kaltental was easy and already after 20 minutes the machine was ready to operate. The consumption of detergent is very economic and this with best washing results. Also the final cleaning after the washing cycle could not be any easier.

All in all a very good thought project - my compliments

With lots of pleasure when cleaning the bottles

Dominik Schrempp

Master brewer